

ASAP™ 2420

Accelerated Surface Area and Porosimetry System

Analytical Versatility with Superior Throughput

ASAP 2420 Accelerated Surface Area and Porosimetry System

Surface area and porosity are important physical properties that influence the quality and utility of many materials and products. Therefore it is critically important that these characteristics be accurately determined and controlled. Likewise, knowledge of surface area and especially porosity often are important keys in understanding the formation, structure, and potential application of many natural materials.

High Performance/High Sample Throughput

The ASAP 2420 system is designed to help today's busy laboratories expand their workflow while providing highly accurate and precise surface area and porosimetry data. High performance and versatile analysis and sample preparation systems are included in the same instrument.

Analysis System

- With six independently operated analysis ports, a new analysis can begin as soon as another is finished. This provides an important advantage over many multiport instruments that require all samples to be prepared or analyzed at the same time.
- Extended analyses can be performed without refilling the Dewar. This allows unattended analysis of high resolution adsorption/desorption isotherms that take much longer to complete because the system must equilibrate at each data point.
- BET surface area analyses utilizing six parallel runs can be achieved in as little as 30 minutes.
- A low surface area option that uses krypton as an adsorptive to measure total surface areas of 5 m² or less is available. This option utilizes five of the six available ports. It also features a turbomolecular drag pump, which provides the high vacuum required for krypton analyses, and a 10-mmHg pressure transducer, which allows accurate, repeatable pressure resolution.

- Intuitive and powerful Windows®-based software allows more versatility in data archiving, networking, and printer options. However, the most powerful features of this software are found in its expanded range of data reduction and reporting.
- Long-duration Dewars and patented Isothermal Jackets assure a constant thermal profile along the length of both the sample and saturation pressure (P₀) tubes throughout extended analyses. The P₀ value may be entered, or measured either continuously or at selected intervals.

Sample Preparation System

- The ASAP 2420 system includes twelve automatically controlled sample preparation ports that operate independently.



Samples may be added or removed from degas ports without disturbing the treatment of other samples undergoing preparation or analysis.

- The sample preparation system is fully automated with controlled heating time profiles. Temperature and ramp rate can be set and monitored individually and controlled from a few degrees above ambient to 450 °C. The temperature hold period may extend past the point when evacuation is completed.
- A programmable pressure threshold can suspend the temperature ramp if the outgassing pressure exceeds the limit specified, preventing destructive steaming or other undesired reactions with residual gasses and vapors.

Typical ASAP 2420 Applications

Pharmaceuticals – Surface area and porosity play major roles in the purification, processing, blending, tableting, and packaging of pharmaceutical products as well as their useful shelf life, dissolution rate, and bioavailability.

Ceramics – Surface area and porosity affect the curing and bonding of greenware and influence strength, texture, appearance, and density of finished goods. The surface area of glazes and glass frits affects shrinkage, crazing, and crawling.

Adsorbents – Knowledge of surface area, total pore volume, and pore size distribution is important for quality control of industrial adsorbents and in the development of separation processes. Surface area and porosity characteristics affect the selectivity of an adsorbent.

Activated Carbons – Surface area and porosity must be optimized within narrow ranges to accomplish gasoline vapor recovery in automobiles, solvent recovery in painting operations, or pollution controls in wastewater management.

Carbon Black – The wear lifetime, traction, and performance of tires are related to the surface area of carbon blacks used in their production.

Catalyst – The active surface area and pore structure of catalysts influence production rates. Limiting the pore size allows only

molecules of desired sizes to enter and exit, creating a selective catalyst that will produce primarily the desired product.

Paints and Coatings – The surface area of a pigment or filler influences the gloss, texture, color, color saturation, brightness, solids content, and film adhesion properties. The porosity of a print media coating is important in offset printing where it affects blistering, ink receptivity, and ink holdout.

Projectile Propellant – The burn rate of propellants is a function of surface area. Too high a rate can be dangerous; too low a rate can cause malfunction and inaccuracy.

Medical Implants – Controlling the porosity of artificial bone allows it to imitate real bone that the body will accept and allow tissue to be grown around it.

Electronics – By selecting high surface area material with carefully designed pore networks, manufacturers of super-capacitors can minimize the use of costly raw materials while providing more exposed surface area for storage of charge.

Cosmetics – Surface area is often used by cosmetic manufacturers as a predictor of particle size when agglomeration tendencies of the fine powders make analysis with a particle-sizing instrument difficult.



Aerospace – Surface area and porosity of heat shields and insulating materials affect weight and function.

Geoscience – Porosity is important in groundwater hydrology and petroleum exploration because it relates to the quantity of fluid that a structure can contain as well as how much effort will be required to extract it.

Nanotubes – Nanotube surface area and microporosity are used to predict the capacity of a material to store hydrogen.

Fuel Cells – Fuel cell electrodes require high surface area with controlled porosity to produce optimum power density.



Superior Data Presentation Capability

Operating Software

The ASAP 2420 Windows interface provides a familiar environment for the user. It is easy to collect, organize, archive, and reduce raw data, and store standardized sample information for later use. The reports may be generated to screen, paper, or data transfer channels. Cut-and-paste graphics, scalable-and-editable graphs, and customized reports are easily generated.

ASAP 2420 Advantages

- ✓ Fully automated analyses
- ✓ High throughput with six independent analysis stations
- ✓ Each analysis port has a dedicated analysis and P_0 pressure transducer
- ✓ Twelve independently controlled degas ports
- ✓ Evacuation rate precisely regulated by a servo valve
- ✓ BET surface area measurements in as little as 30 minutes
- ✓ Dosing options of maximum volume increment or dosing over specified pressure ranges
- ✓ Analysis temperature can be entered, calculated, or measured
- ✓ Equilibration option allows user to specify equilibration times for different parts of the isotherm
- ✓ Low surface area option with five independent analysis ports
- ✓ Windows-driven software

In addition to controlling the instrument's operation, the Windows software also reduces the raw data collected during analysis. The reduced data can be reviewed or printed in a variety of easy-to-interpret tabular and graphical reports. These include:

- Single-point and multipoint BET surface area
- Total pore volume
- Langmuir surface area and Isotherm reports
- t-Plot
 - Harkins and Jura Thickness equation
 - Halsey Thickness equation
 - Carbon STSA
 - Broekhoff-de Boer
 - Kruk-Jaroniec-Sayari

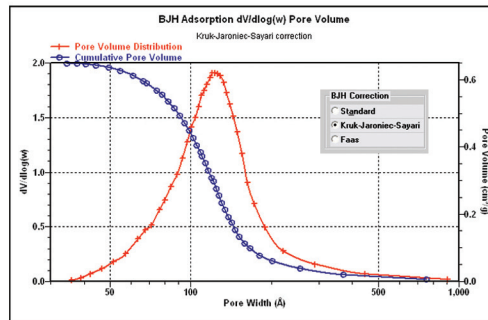

The ASAP 2420 includes long-life Dewars to allow convenient analysis of porous materials and determination of pore size distributions. The ASAP 2420 includes a full suite of options for characterizing porosity including advanced options for BJH calculations. An example pore size distribution for an amorphous silica alumina is shown above.

Both mesoporous and microporous samples may be characterized using the convenient built-in t-plot reports. An example t-plot analysis illustrates the graphical and statistical reports that are easily generated. The ASAP 2420 also includes an extensive list of statistical t-curves as well as the use of reference t-curves. These options provide users with flexibility to use traditional and advanced solutions for their material characterizations.

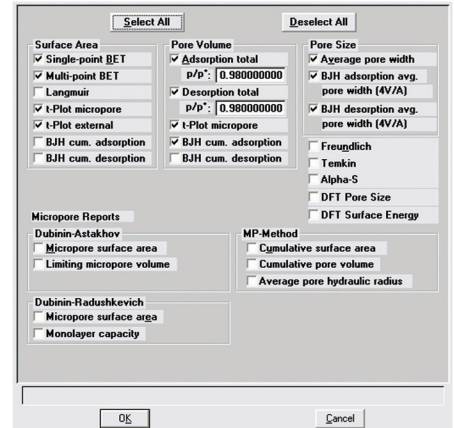
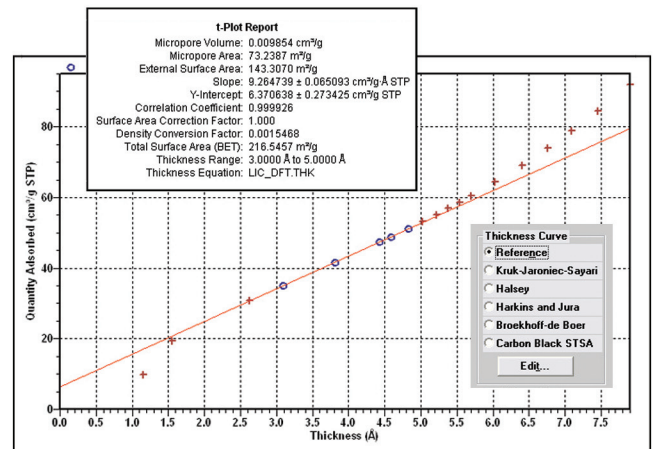

Reports selection screen

- BJH adsorption and desorption
 - Standard
 - Kruk-Jaroniec-Sayari correction
- Mesopore and Macropore
 - Volume and area distributions by pore size
- MP-Method
- DFT pore size
- DFT surface energy
- Summary report

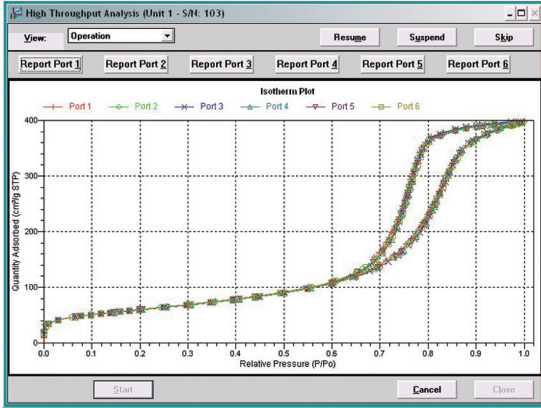

The ASAP 2420 "High Throughput" analysis allows users to start up to six analyses simultaneously. The overlaid results from six samples of high surface area silica alumina are shown here.

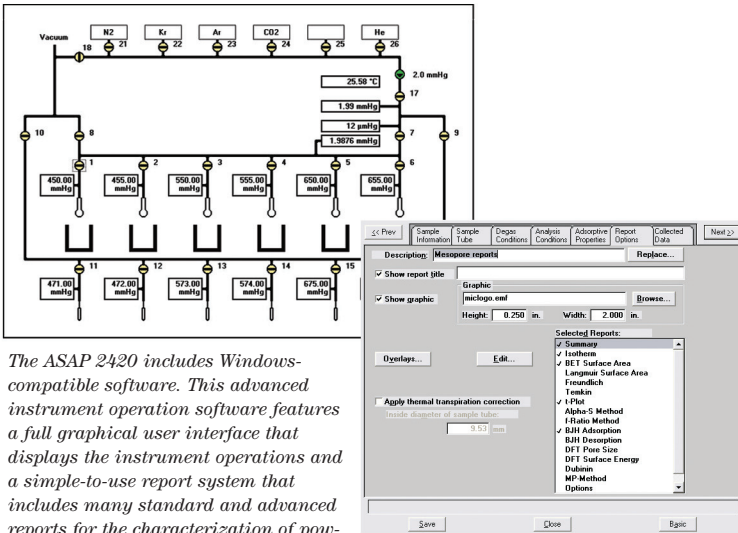

The ASAP 2420 includes Windows-compatible software. This advanced instrument operation software features a full graphical user interface that displays the instrument operations and a simple-to-use report system that includes many standard and advanced reports for the characterization of powders and porous materials.

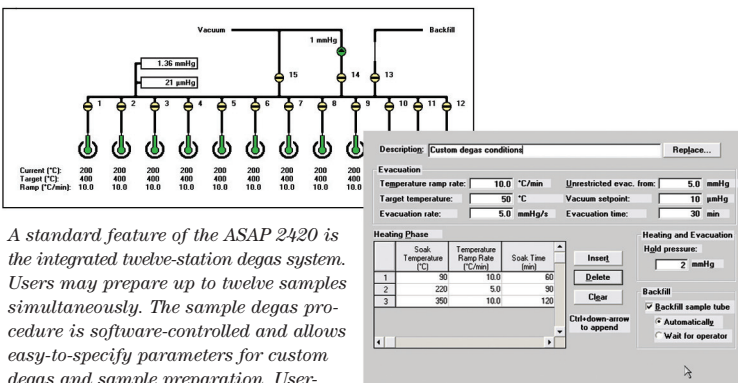

A standard feature of the ASAP 2420 is the integrated twelve-station degas system. Users may prepare up to twelve samples simultaneously. The sample degas procedure is software-controlled and allows easy-to-specify parameters for custom degas and sample preparation. User-defined evacuation rates and temperature ramps are provided to support even the most difficult-to-prepare samples.

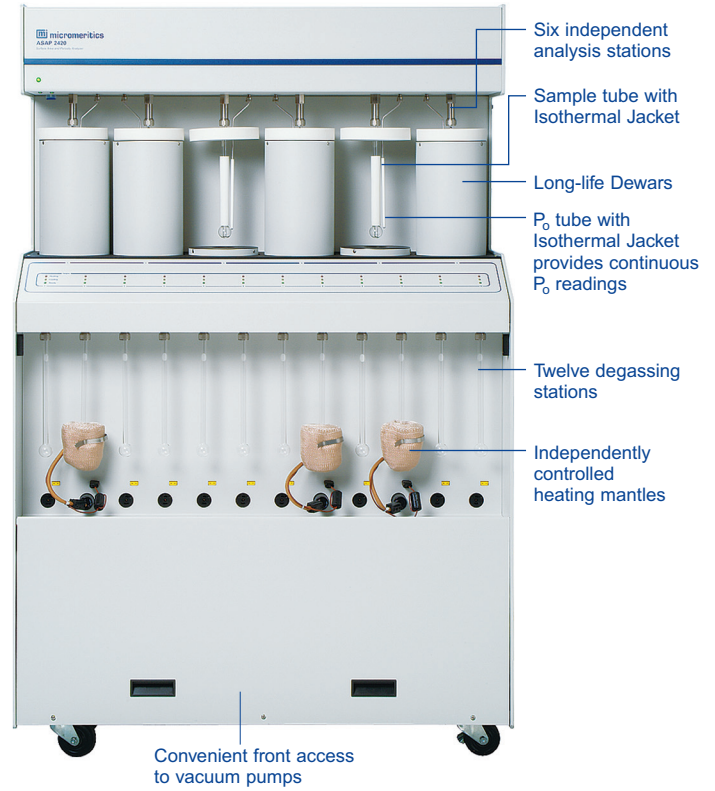

Six independent analysis stations

Sample tube with Isothermal Jacket

Long-life Dewars

P₀ tube with Isothermal Jacket provides continuous P₀ readings

Twelve degassing stations

Independently controlled heating mantles

Convenient front access to vacuum pumps

Six analysis gas inlets

Degas Backfill

Degas backfill gas inlet

To request a quote or additional product information, visit Micromeritics' web site at www.micromeritics.com, contact your local Micromeritics sales representative, or our Customer Service Department at (770) 662-3636.



The Science and Technology of Small Particles™

Micromeritics Instrument Corporation
One Micromeritics Drive
Norcross, GA 30093-1877
USA

Telephones:

U.S. Sales (770) 662-3633
International Sales (770) 662-3660
Fax (770) 662-3696

Micromeritics China
Apt. 5H, No. 1 Building
Hua-Ao (Epoch) Center
No. 31 Zi Zhu Yuan Road
Hai Dian District
Beijing 100089

P.R. CHINA

Telephone (+86) (0)10-6848-9371
Fax (+86) (0)10-6848-9371

Micromeritics France S.A.
Parc Alata
Rue Antoine Laurent Lavoisier
F-60550 Verneuil en Halatte

FRANCE

Telephone (+33) (0)3 44 64 60 80
Fax (+33) (0)3 44 64 60 89

Micromeritics GmbH
Erfststrasse 54
D-41238 Mönchengladbach

GERMANY

Telephone (+49) (0)2166-98708-0
Fax (+49) (0)2166-98708-88

Micromeritics Ltd.
Unit 2, Chestnut House
178-182 High Street North
Dunstable, Bedfordshire LU6 1AT
ENGLAND

Telephone (+44) (0)1582-475248
Fax (+44) (0)1582-475252

Micromeritics N.V./S.A.
Eugene Plaskyiaan 140B
1030 Brussels

BELGIUM

Telephone (+32) (0)2-743-39-74
Fax (+32) (0)2-743-39-79

Micromeritics SRL
Via W. Tobagi n. 26/7
20068 Peschiera Borromeo
Milano

ITALY

Telephone (+39) (0)2 553 02833
Fax (+39) (0)2 553 02843